

## SUMMARY OF STATE HERITAGE PLACE

---

### REGISTER ENTRY

Entry in the South Australian Heritage Register in accordance with the *Heritage Places Act 1993*

---

**NAME:** Semaphore Carousel

**PLACE NO.:** 26552

**ADDRESS:** Karna Country

Esplanade, Semaphore

CR 6230/172 D42723 A103 Hundred of Port Adelaide

### STATEMENT OF HERITAGE SIGNIFICANCE

The Semaphore Carousel demonstrates important aspects of the State's history of leisure and entertainment, specifically the development of seaside resorts as places for South Australians to use new leisure time for daytrips and holidays. The Carousel was first located at Henley Beach from 1928 before being permanently relocated to the Semaphore foreshore in 1938. The Semaphore Carousel is a rare surviving example of the carousels that were a popular attraction at South Australia's seaside resorts and followed the traveling show circuit. It is also the only carousel known to have been manufactured in South Australia, albeit with horses carved in Melbourne.

### RELEVANT CRITERIA (under section 16 of the Heritage Places Act 1993)

**(a) *it demonstrates important aspects of the evolution or pattern of the State's history***

The emergence of leisure time in the late nineteenth century arose after changes to working conditions enabled a growing number of people to access public holidays and annual leave. Consequently, people sought new places and ways to spend their leisure time. South Australia with its extensive coastline and sandy beaches offered many opportunities for the development of seaside resorts. Semaphore was an early and popular destination due to its close proximity to Adelaide. The extension of the railway to Semaphore in 1878 with its station adjacent to the foreshore further enhanced Semaphore's popularity.

To provide activities other than the beach and to increase opportunities to support businesses a number of improvements to the foreshore took place, including the establishment of a range of amusements. Some of the amusements

were permanent and operated year-round, while others were itinerant setting up on the foreshore during the summer, including three carousels by the early twentieth century.

Carousels (transportable) were a typical amusement at South Australia's seaside resorts in the summer including at Glenelg and Henley Beach and also followed the show circuit offering entertainment across the state. Unlike these transportable carousels that are believed to have been made in the UK or USA, the Semaphore Carousel was made in South Australia, with horses carved in Melbourne and constructed at a permanent site on the Henley Beach foreshore in 1928 by businessman Len Northey.

In 1938, Len Northey relocated the carousel to its new permanent home on the Semaphore foreshore taking advantage of the tourists who flocked there for a day-trip, holiday or the annual Semaphore Illuminated Carnival. The Semaphore Carousel is strongly associated with the activities that attracted people to South Australia's seaside resorts demonstrating changes in working conditions that provided access to new leisure time and aspects of the development of South Australia's tourism industry.

**(b) it has rare, uncommon or endangered qualities that are of cultural significance**

Carousels were and remain a popular attraction in South Australia, with travelling carousels often following the show circuit around the state, while permanent (fixed) or semi-permanent carousels still operate on the Semaphore and Glenelg foreshores. With the exception of the Semaphore Carousel which was made in South Australia with horses manufactured in Melbourne, the carousels operating in South Australia in the late nineteenth century and first half of the twentieth century are believed to have been imported from the UK and USA. Carousels built during this heyday of early amusement rides are becoming increasingly rare globally. The carousels at Semaphore and Glenelg are the only known carousels remaining in South Australia from this period.

Although carousels are still being manufactured overseas, the Semaphore Carousel is the only known South Australian-made carousel, albeit with horses carved in Melbourne. Nationally, it is also a rare example of an Australian-made carousel, with the only other known Australian-made carousel still in operation located at the Perth Zoo.

# SITE PLAN

Semaphore Carousel  
Karna Country  
Esplanade Semaphore



PLACE NO.: 26552



Land Parcel Semaphore Carousel Esplanade, Semaphore (CR 6230/172 D42723 A 103 Hundred of Port Adelaide)

## LEGEND

N ↑

-  Parcel boundaries (Indicates extent of Listing)
-  Detail (see below for elements of significance for Semaphore Carousel)
-  Existing State Heritage Places 1) Semaphore Palais (SHP 13952); 2) Soldiers Memorial Clock (SHP 143621); 3) Semaphore Pier (known as Semaphore Jetty) (SHP 14360)

Summary of State Heritage Place: 26552  
Provisionally entered by the South Australian Heritage Council on 16 February 2023  
Confirmed by the South Australian Heritage Council on [add date] (tbc)

3 of 24

# SITE PLAN



Semaphore Carousel

PLACE NO.: 26552



## LEGEND

N ↑

-  Extent of the elements of significance associated with the Semaphore Carousel (CR 6230/172 D42723 A 103 Hundred of Port Adelaide)
-  Shed/lean-to to carousel pavilion, considered to not contribute to the significance of place

### Elements of heritage significance include (but are not necessarily limited to):

- Carousel,
- Horses,
- Carriages
- Original and early mechanical and decorative components, features and fittings,
- Octagonal pavilion, doors and operator's box, including controller, ticket window and hourglass timer.

### Elements not considered to contribute to significance of place include (but are not necessarily limited to):

- Bulb batten holders,
- Applied ornamental rosettes, scrolls, figures and painted panels,
- Drop panels hooked to sweeps,
- Paint finish,
- Freestanding timber supports to pavilion,
- Lean-to shed to north
- All other buildings, shelters, amusements, landscaping in the immediate vicinity of the area identified as significant.

N ↑

## COMMENTARY ON THE LISTING

### Description and notes with respect to a place entered in the South Australian Heritage Register in accordance with the *Heritage Places Act 1993*

---

#### Physical Description

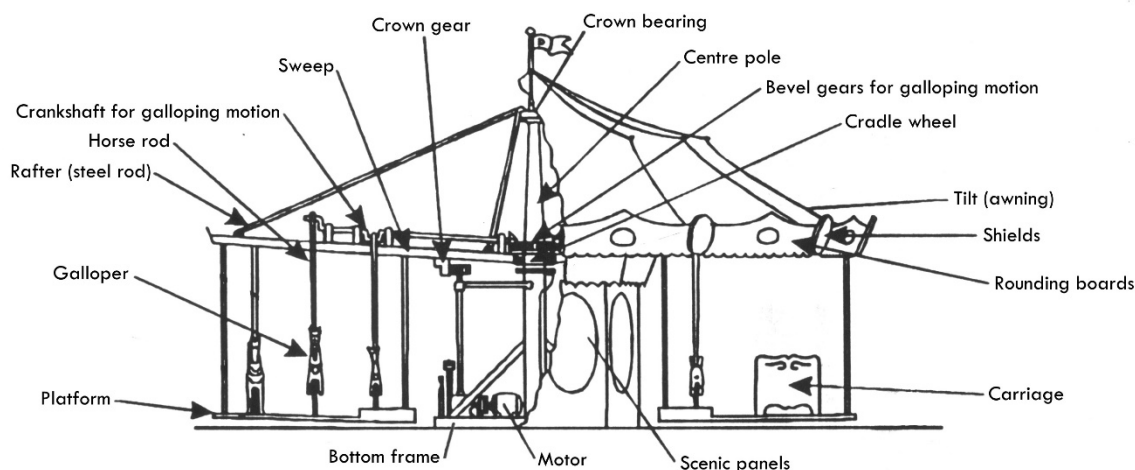

**Components of a typical carousel**

Source: adapted by Heritage South Australia from <https://www.dentzel.com/>

The Semaphore Carousel is a timber and steel, electrically-driven platform carousel with 36 horses (originally 40 horses and two carriages), arranged in three-abreast configuration with *galloping* (vertical reciprocating) motion. The Carousel is comprised of a stationary *centre* (hub) and a rotating *spinning frame*.

The centre stands on a concrete pad and is in turn comprised of a timber and steel supporting structure with a steel *centre pole*, *crown bearing*, *crown gear* and *cradle wheel*. The centre is enclosed within Oregon pine, cedar and pressed metal *scenic panels* forming an octagonal *console*, features of which include:

- coved upper soffit in pressed metal,
- pressed metal lower panels,
- double mirror panels on four sides at head height,
- bevelled and etched upper mirrors,
- speaker apertures in four sides at head height, with plywood fretwork inserts representing a lyre and cloth backing [original speakers removed],
- fielded console panels,
- mirrored glass jewels to fielded panels,
- fluted and beaded decoration and bosses to panel and field edges [original fabric],



- applied ornamental rosettes, scrolls, figures, and painted panels [not original fabric],
- access door in one lower panel,
- fixed internal ladder.

The spinning frame is suspended from the crown bearing and is comprised of Oregon sweeps (spokes) slotted into the cradle wheel, locked together with Oregon *quarterings* (spacers) and encircled by decorative pressed metal *rounding boards*. The sweeps are stayed to the crown bearing with steel rod *rafters*. Features of the spinning frame include:

- pressed metal shields [early fabric, replaced c.1938],
- stopped chamfers to sweeps and quarterings,
- drop panels suspended from the sweeps and quarterings by hooks [not original fabric],
- cambered Oregon pine platform suspended from spinning frame on brass *drop rods* with diagonal braces,
- *galloping motion* including crankshafts mounted above, with carved wooden horses suspended from the crankshafts on brass *horse rods*,
- barley-twist drop rods, horse rods and braces, all chrome-plated,
- lattice 'ceiling,'
- leather or vinyl saddles and reins; cast stirrups, and horsehair or synthetic tails to horses [replaced progressively over time reflecting ongoing use],
- slots in platform allowing horse-rods to swing outwards with centripetal force.

180 bulb batten holders are positioned on the sweeps, rounding boards and centre console of the Carousel [original positions but not original fabric, replaced recently]. The Semaphore Carousel is housed in an octagonal timber and corrugated steel pavilion, with clerestory windows and timber-framed sliding doors on seven sides (originally on all sides) and a lean-to shed [not original fabric] on the northern side. Five of the remaining sliding doors are now fixed in position. The pavilion is surmounted by a timber mast which originally supported two banks of 'walking' lights. Additional features of the Carousel pavilion include:

- operator's box, including ticket window, revolving hourglass timer, and tram-style speed controller,
- freestanding timber roof support posts [not original fabric],
- asphalt surface.

### **Elements of Significance:**

Elements of heritage significance include (but are not necessarily limited to):

- Carousel,
- Horses,
- Carriages
- Original and early mechanical and decorative components, features, fittings,

- Octagonal pavilion, doors and operator's box, including controller, ticket window and hourglass timer.

Elements not considered to contribute to significance of place include (but are not necessarily limited to):

- Bulb batten holders,
- Applied ornamental rosettes, scrolls, figures and painted panels,
- Drop panels hooked to sweeps,
- Paint finish,
- Freestanding timber supports to pavilion,
- Solar panels and lean-to shed to north.

### **History of the Place**

*Please refer to the Assessment Report for the full history.*

The Semaphore Carousel was built in 1928 for Leonard (Len) Robert Northey. During the early 1920s Len Northey was an Adelaide-based clothing manufacturer in partnership with his brother Albert Edwin, trading as Northey Brothers Limited from October 1923.<sup>1</sup> In April 1925, Northey Brothers' premises of the top floor of a two-story Currie Street building were gutted by fire, resulting in £3,000 damage.<sup>2</sup> Northey Brothers Limited subsequently went into liquidation.<sup>3</sup>

Afterwards Len and Albert Northey<sup>4</sup> leased the Henley Beach Town Hall (SHP 10558, completed 1922<sup>5</sup>) where they screened silent films, trading as Henley Pictures from 1926.<sup>6</sup> Concurrently, Albert was an elected member of the Council of Henley and Grange for at least twenty years from about 1925,<sup>7</sup> later serving as mayor 1946-1948.<sup>8</sup> Albert was also a local builder and contractor<sup>9</sup> living at Henley Beach.<sup>10</sup>

The success of Baxter's Glenelg carousel reportedly inspired Northey to build his own 'bigger machine'<sup>11</sup> at Henley Beach, allowing him to diversify his business interests.<sup>12</sup> At the end of 1927, most likely before commissioning his carousel horses and mechanism, Northey applied to the Corporation of the Town of Henley and Grange for a five-year lease on a site for a carousel at Henley Beach. The Corporation accepted Northey's application, charging an initial annual rent £80, increasing by £10 each year over five years.<sup>13</sup>

With this agreement in place, the Corporation of the Town of Henley and Grange extended an existing<sup>14</sup> 'amusement platform'<sup>15</sup> to accommodate Northey's carousel during mid-1928, comprising a clayed surface over sand fill.<sup>16</sup> The Corporation also built an electrical switch house for the carousel, measuring 8 by 5 feet.<sup>17</sup> Other foreshore improvements implemented around the same time included concrete bathing houses, foreshore lighting and an underground power supply.<sup>18</sup>

Meanwhile, Northey commissioned the mechanism and 40 horses for his carousel. Unable to find a local craftsman, Northey commissioned Robert (Bob) Bartlett of

Robert Bartlett & Co., Melbourne to create the horses at a cost of £20 per head.<sup>19</sup> Having worked as a rocking-horse maker since 1913, the carousel horses commissioned by Len Northey represented Bartlett's 'first venture into carousel horse making.'<sup>20</sup>

Bartlett based the design for Northey's horses on German Heyn horses from Weinger's carousel outside Luna Park on the St Kilda (Melbourne) foreshore. Bartlett made the bodies from 'easily carved and fairly knot-free' sugar and yellow pine while legs, ears 'and often heads' were carved from harder Kauri pine. The horses for Northey's carousel were plainer than the prototype Heyn horses<sup>21</sup> to reduce the cost<sup>22</sup> and perhaps also save time, considering the size of the order. Bartlett applied steam-bent veneer strips 'instead of carved caparisons,' added glass eyes and metal 'jewels,' and most of the horses 'were painted as eye-catching dapple-grays' using his 'new spray gun,' with a few black, cream and chestnut horses<sup>23</sup> included for variety.

The spinning frame of Northey's carousel revolved around a 10-inch diameter, ½-inch section high tensile tramway power pole, obtained second-hand from the Municipal Tramways Trust (MTT).<sup>24</sup> Reputedly, the crown gear was cast in Whyalla<sup>25</sup> and overhead crankshafts forged by Forwood Down & Company,<sup>26</sup> while machining was carried out at the South Australian Railways' Islington Workshops.<sup>27</sup> Northey also imported twisted brass rods from England,<sup>28</sup> which were later chrome-plated to eliminate the need for regular polishing. Carpentry and final assembly was likely carried out by Len and his brother, contractor Albert Northey.

In early May 1928 Len Northey wrote to the Corporation requesting permission to build a 'shed' (pavilion) on the platform 'almost immediately' so that 'construction of the machine may be finished in the shed':

The reason is quite obvious as with the wet weather commencing it is almost impossible to do construction work with the timber satisfactorily outside, to prevent it from shrinking and buckling, besides the fact that the machinery would not be improved outside.

The Corporation granted permission to build the pavilion, which Northey described as:

...all new materials ... painted inside and outside, to be shaped eight sided and half of each side would be a sliding door, width of shed side to side 64ft., joint to joint 70ft., 22ft. high in centre walls 10ft., roof and walls galvanised iron except one foot of wall would be glass right round to show coloured lights<sup>29</sup> [bulbs were mounted inside around the perimeter of the shed so as to be visible from outside].<sup>30</sup>

When the carousel was completed, its 'weather-proof' pavilion with large sliding doors made it suitable for use 'in any kind of weather.'<sup>31</sup> Unlike Baxter's Riding Gallery at



Glenelg, which could be mounted on a wagon chassis to facilitate regular relocation, Northey's carousel is believed to have stood on a concrete pad and was intended to be a permanent structure.<sup>32</sup>

Northey's carousel is understood<sup>33</sup> to have been the first in South Australia to employ amplified music and was possibly the first to do so in Australia.<sup>34</sup> Music was supplied via a phonograph and valve amplifier to four speakers mounted behind openings in the central console. This innovation was made possible by the appearance of electromagnetic phonograph pickups in the mid- to late-1920s.<sup>35</sup> When completed in November 1928, the carousel was 'electrically fitted' so that Northey could 'issue tickets, set the machine in motion and start the music simultaneously'<sup>36</sup> from an operator's box near the door, meaning he did not need to employ a hand to help him operate the ride.

There is no evidence to suggest Northey's carousel was originally driven via a horizontal belt looped around the circumference of the platform, as has been claimed.<sup>37</sup> It has also been claimed that the current drive, comprising a lift motor and gearbox dating from 1915, was salvaged from a building destroyed by fire in 1930.<sup>38</sup> Given the availability of reliable documentation of the Northey Brothers Limited fire in 1925, it is suggested the current drive may be the original drive, salvaged from the Northey's Currie Street premises after the fire. The current motor throttle controller in the operator's box appears to be from an electric tram, rather than an electric lift as suggested by oral history.<sup>39</sup>

On 22 December 1928, Northey paid £3 to licence his carousel, with a capacity of 60, for one year. The carousel was operational at Henley Beach by 29 December 1928, when it was described as 'new'.<sup>40</sup> Later, in August 1930, Northey promoted his carousel in the amusement pages of the *Advertiser* as 'the big de luxe [sic] merry-go-round ... open each afternoon.'<sup>41</sup>

Northey's agreement with the Corporation of the Town of Henley and Grange, prepared by Northey's own solicitor,<sup>42</sup> included a clause preventing the construction of similar 'riding devices' on the Henley Beach foreshore by rival amusement proprietors. For example, in September 1929, the Corporation refused A. S. Belcher permission to build a 'Dodgem Riding Device' on the amusement platform adjacent to Northey's carousel.<sup>43</sup>



**Northey's carousel at the Jubilee Oval, 1936, note original shields on rounding boards replaced c1938.**

Source: Semaphore Carousel historical display

South Australia's Centenary in 1936, Northey was invited to move his carousel to the Jubilee Oval, located behind the Jubilee Exhibition Building on North Terrace,<sup>44</sup> a potentially lucrative business opportunity. For its temporary appearance at Jubilee Oval, the carousel received a canvas *tilt* or canopy<sup>45</sup> to keep the rain out while the octagonal pavilion remained behind. After its appearance at the Jubilee Oval, Northey's carousel returned to Henley Beach where it remained until 1938.<sup>46</sup>



**Northey's carousel at Henley Beach, 1938.**

Source: Skyways (photographer), SLSA B 7517

### *Moving to Semaphore*

Northey was lured<sup>47</sup> to move his carousel to Semaphore by the growth of the Semaphore Carnival in the late 1930s, in turn buoyed by the Broken Hill holiday crowds<sup>48</sup> which travelled to Semaphore by train. A proposal to lease a portion of the Todd reserve on the foreshore in 1936 for a permanent carousel was met with 'indignation' by the local community who argued that the reserve 'belongs to the rate payers and the public generally, and should not be closed for the sake of a few pounds in revenue'.<sup>49</sup>

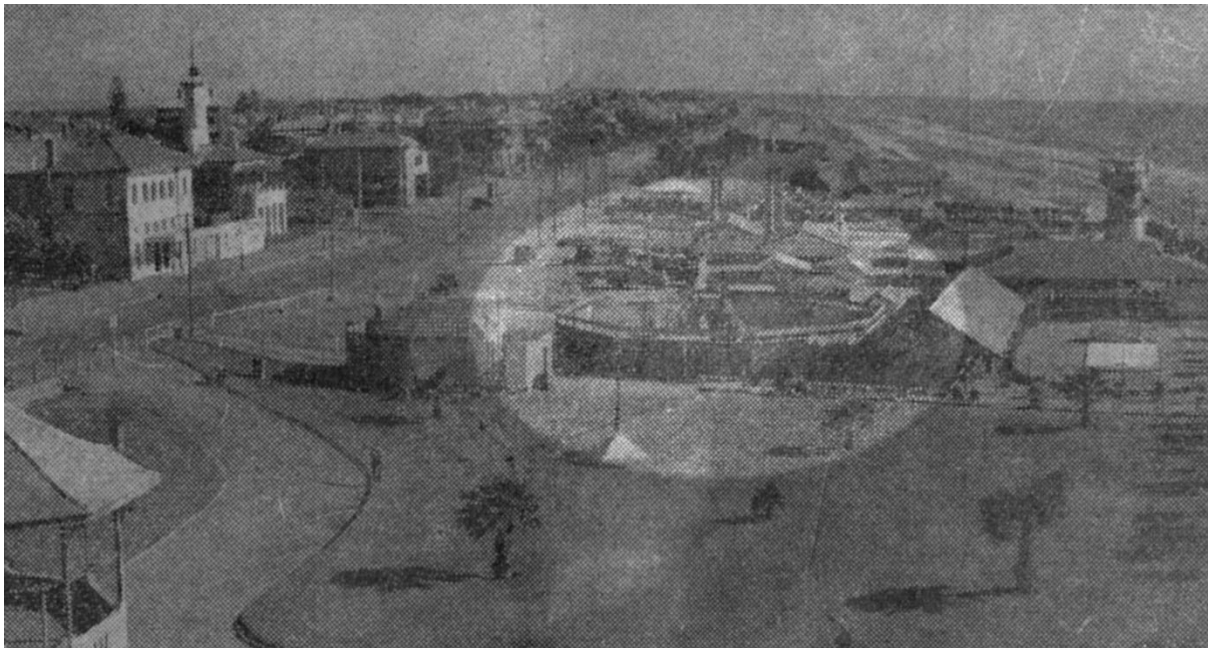

**Northey's carousel under reconstruction at Semaphore, December 1938.**

Source: "Carnival Site" in *Citizen* 31 December 1938 p. 1 <http://nla.gov.au/nla.news-article236745358>

However, it seems the opposition was short-lived, as on 4 November 1938, the *Advertiser* reported Northey's 'large merry-go-round' would open at Semaphore for the first time, at the eight-day Semaphore Carnival beginning on 24 December.<sup>50</sup> A photograph published in *The Citizen: Port Adelaide & District News Pictorial* on 31 December 1939 shows Northey's carousel pavilion in course of reassembly in its current position,<sup>51</sup> on the lawns south of the Semaphore Palais (SHP 13952).

Following the highly successful<sup>52</sup> 1938-1939 Semaphore Carnival, Len Northey consolidated his interests at Semaphore by leasing the Semaphore Palais from the Corporation of the City of Port Adelaide in 1940.<sup>53</sup> After deciding the move to Semaphore would be a permanent one, Northey cut up his carousel's canvas tilt to make shelter shades for beach hire.<sup>54</sup> Pressed metal shields on the Carousel's rounding boards were also replaced around this time.

Known locally as 'the Merry-go-round Man,' Len Northey played an important role in maintaining the momentum of the Semaphore Carnival in the post-war years as



Chairman of the Semaphore Carnival Committee.<sup>55</sup> He died in 1966; afterwards his son, Robert Douglas Northey (b.1927) took over responsibility for the Carousel.<sup>56</sup>

#### *Later years*

After about seven years, Robert Northey sold the Semaphore Carousel at an auction held in Tanunda in 1974.<sup>57</sup> It was purchased for \$22,000<sup>58</sup> by father and son, Brent (snr) and Brent (jnr) Leighton. Brent (jnr) maintained and operated the Carousel into the late-1980s when Ernie and Kath Makepeace took over,<sup>59</sup> however, ownership remained in the Leighton family. Ernie Makepeace regularly repaired broken horse legs 'using fibreglass sections which seamlessly match the design of the horses.'<sup>60</sup> The horses are now understood to be protected beneath thin fibreglass shells. Ernie also suspended drop panels from the sweeps and added applied decoration to the platform edges, carriages and centre panels.<sup>61</sup>

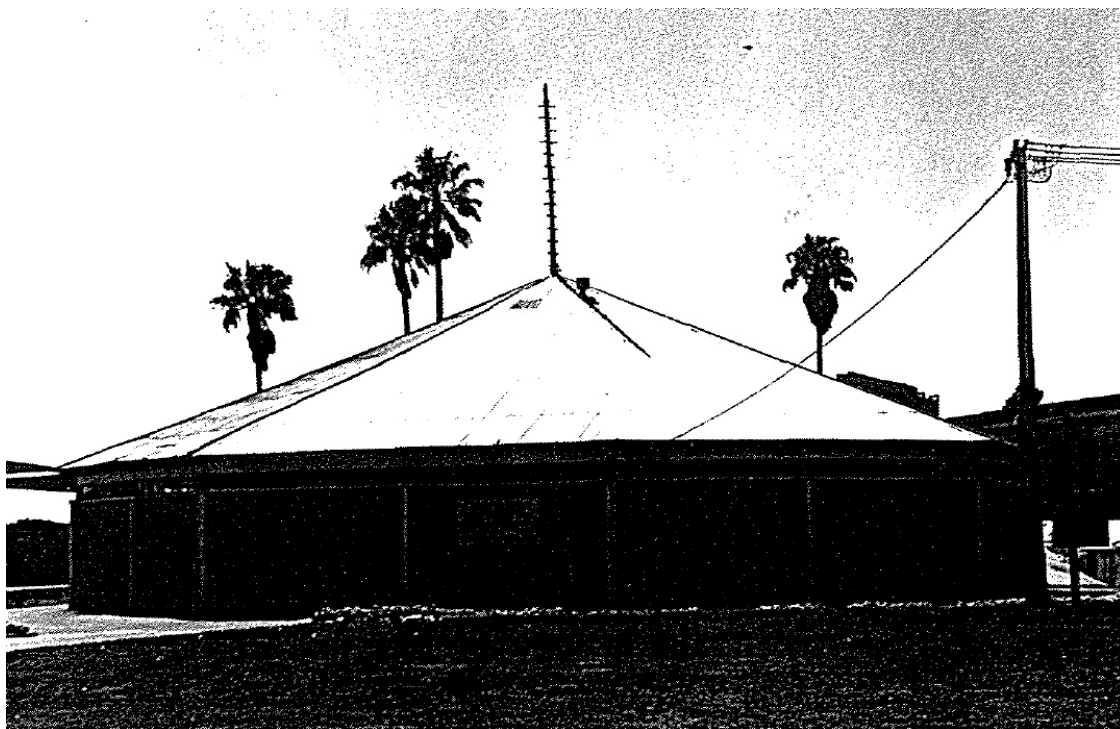

**Semaphore Carousel Pavilion, 1989, note 'walking lights' on mast.**

Source: McDougall & Vines (1989) *Greater Port Adelaide Conservation Study*, Architecture Museum Collection

During the early 2010s Kath's ill health led the Makepeaces to retire and Brent Leighton (jnr) advertised the Semaphore Carousel for sale in February 2011. Later that year, Peter Lohman and partner Dea Wilke took over operation of the Carousel. In October 2011 Adelaide City Council investigated buying the Semaphore Carousel and relocating it to Rundle Mall under the Gawler Place canopy.<sup>62</sup> Doubts surrounding the future of the Carousel in the early 2010s led to community concerns that the ride could be 'dismantled and the individual horses auctioned off.'<sup>63</sup>

Retired businessman Frank Schirripa purchased the Semaphore Carousel in March 2014. Since then, the Carousel has been operated by the Rotary Club of Henley

Beach, who have used the proceeds 'to fund a range of local and international charity projects.'<sup>64</sup> In recent years the Carousel was modified to accommodate wheelchairs by removing four horses and partially removing the carriages.

Today the Semaphore Carousel is believed to be the largest in Australia<sup>65</sup> and one of two surviving and operational pre-1945 Australian-built carousels. It is also the only operational carousel fitted with Bartlett carousel horses.<sup>66</sup> Highly regarded by carousel enthusiasts internationally, the Semaphore Carousel is considered to have unusually smooth mechanical action.<sup>67</sup>



**View of Semaphore Carousel showing 'galloping' horses.**

Note: unless otherwise indicated the images in this report were taken during the site visit on 2 November 2022.

## **Chronology**

<b>Year</b>	<b>Event</b>
-------------	--------------

1849	Area now known as Semaphore surveyed.
------	---------------------------------------

1857	Construction of Semaphore Signal Station.
------	---

1857	28 December, early recorded appearance of a carousel in South Australia.
------	--

1859	Construction of Semaphore Jetty (SHP 14360) commences.
------	--

Summary of State Heritage Place: 26552

Provisionally entered by the South Australian Heritage Council on 16 February 2023

Confirmed by the South Australian Heritage Council on [\[add date\]](#) (tbc)

- 1860s Organised sporting competitions occur at Semaphore.
- 1867 Frederick Savage of King's Lynn develops the steam-driven carousel.
- 1878 Port Adelaide railway line extended to Semaphore.
- 1880s Galloping motion developed.
- 1885 Frederick William (Fred) Baxter arrives in Australia from England, importing the first steam-powered carousel into Australia.
- 1888 Construction of baths at seaward end of Semaphore Jetty.
- 1889 18 January, bandstand or rotunda opens on Semaphore Reserve.
- 1892 9 November, First annual sporting carnival held at Semaphore.
- 1896 Part of Semaphore Reserve renamed Todd Reserve after Mayor Todd.
- 1902 Baxter's Riding Gallery imported from England.
- 1909 Semaphore Open Air Pavilion (later Ozone Pavilion) opens.
- 1910 Semaphore Wondergraph Open Air Picturedrome opens.
- 1913 Robert (Bob) Bartlett enters business as a rocking-horse maker.
- 1914 Electrically-driven carousels operating in South Australia.  
Kiosk opens on Semaphore jetty.
- 1917 Semaphore baths damaged by storm.
- 1919 15 December, Municipal Tramways Trust bandstand opens at Semaphore.
- 1920 24-26 January, first Semaphore Illuminated Carnival.
- 1922 23 December, Semaphore Bathing Pavilion (Semaphore Palais) opens.
- 1923 October, Leonard (Len) Robert and Albert Edwin Northey commence trading as Northey Brothers Limited.
- 1925 The Brunswick Panatropé, the first fully electric phonograph, is introduced.  
January, three carousels operating on Semaphore foreshore including Barr's carousel, Pastimes' Royal British Riding Gallery and an unidentified electrically-driven carousel.  
April, Northey Bros. premises gutted by fire.  
August, Amusement Devices Limited tenders unsuccessful proposal to lease large portions of the Semaphore foreshore to create an amusement park.
- 1926 Len and Albert Northey lease the Henley Beach Town Hall to screen silent films, trading as Henley Pictures.
- 1927 13 December, Len Northey accepts lease of Henley Beach foreshore carousel site.**



- 1928 Len Northey commissions Robert Bartlett & Co., Melbourne to create 40 carousel horses at a cost of £20 per head, Bartlett's first foray into carousel horse-making.**
- May, Northey applies to the Corporation of the Town of Henley and Grange to build carousel pavilion.**
- September, Corporation of the Town of Henley and Grange extends amusement platform to fit Northey's carousel.**
- November, Northey's carousel completed.**
- 22 December, Northey's carousel licenced to carry 60 persons.**
- 29 December, Northey's carousel operational at Henley Beach.**
- 1929 March, the first 'talking' pictures screen in Adelaide.
- 1930 August, Northey's carousel advertised as 'the big de luxe [sic] merry-go-round ... open each afternoon.'**
- Original electric drive of Northey's carousel reputedly replaced with current lift motor drive.**
- Numerous South Australian carousels are scrapped, sold or placed in storage during the Depression.
- 1936 Northey's carousel appears at the Jubilee Oval to celebrate South Australia's Centenary.**
- Northey's carousel returns to Henley Beach.**
- Broken Hill Zinc Corporation picnic committee arranges for special trains to transport workers to Adelaide.
- 1937 January, 500 Pinnaroo residents camp at Semaphore.
- May, Death of Fred Baxter.
- 1938 December, Northey's carousel moved to Semaphore foreshore.**
- 24 December, eight-day Semaphore Carnival commences; record-breaking crowd of 350,000 attend.**
- 1939 December, 8,000 people from Broken Hill travel to Adelaide for summer holidays.
- 1940 Northey leases Semaphore Palais from the Corporation of the City of Port Adelaide.
- 1947 Semaphore jetty kiosk destroyed by fire.
- 1950s Large, organised holidays to Semaphore decline due to rising private car ownership.
- 1966 Len Northey dies, Robert Northey takes over operation of Semaphore Carousel.**

- 1974 Semaphore Carousel sold to Brent (snr) and Brent (jnr) Leighton at an auction held in Tanunda, for \$20,000.**
- 1980s Late in the decade, Ernie and Kath Makepeace take over operation and maintenance of the Semaphore Carousel.**
- 1989 Semaphore Carousel is noted as having state heritage significance in the Greater Port Adelaide Heritage Survey.**
- 2011 February, Brett Leighton (jnr) offers Semaphore Carousel for sale.**
- 2014 Semaphore Carousel purchased by Frank Schirripa.**

## References

### Books and Chapters

- HT Burgess ed. (1909) *Cyclopedia of South Australia* (Adelaide: Cyclopedia Company)
- David Braithwaite (1968) *Fairground Architecture* (London: Hugh Evelyn)
- Corporation of the City of Port Adelaide (1956), *Centenary History of Port Adelaide 1856-1956* (Port Adelaide SA: Corporation of the City of Port Adelaide)
- John Couper Smartt (2021) *Port Adelaide: The History of a Commodious Harbor* (Mile End SA: Wakefield Press)
- Henley and Grange Historical Society (1986) *From Sand and Swamp to Seaside City A Chronicle of the Henley and Grange Area 1836-1986* (Adelaide: Henley and Grange Historical Society)
- Averil Holt (1991) *The Vanishing Sand Commemorating 150 Years of Brighton South Australia* (Adelaide: City of Brighton)
- Rob Linn (2001) *A Land Abounding: A History of the Port-Elliot & Goolwa Region South Australia* (Goolwa: Alexandrina Council)

### Reports and Theses

- Lester Firth & Murton Pty Ltd (1982) *An insight into the Development of Western Adelaide* (Adelaide: Lester Firth & Murton)
- Hamish Ramsay (1988) *Semaphore Palais Conservation and Feasibility Study* (Unley SA: Hamish Ramsay)
- Dylan Walker (2017) *Almost an Institution: Sustaining Rural Exhibition in South Australia (1897-1935)*

### Journals

- Lesley Abell (1994), 'Holidays and Health in Nineteenth and Early Twentieth Century South Australia' in *Journal of the Historical Society of South Australia*, vol. 22, pp. 82-97
- Patricia Mullins, 'Future Uncertain for South Australia's Unique Semaphore Beach Carousel', *Carousel News & Trader* February 2012 p.27.

### Newspapers

- 'New Advertisements', *Adelaide Times* 24 December 1857, p.3
- 'Semaphore Beach', *Adelaide Observer* 11 November 1865, p.1
- 'Semaphore Beach', *Observer* 11 November 1865, p.1
- 'General News', *Express and Telegraph* 25 February 1878, p.1
- 'The Semaphore Rotunda', *Express and Telegraph* 19 January 1889, p.2
- 'Semaphore Sports Day', *Adelaide Observer* 12 November 1892, p.36
- 'Semaphore', *Register* 29 October 1896, p.10
- 'The Holiday. Semaphore Sports', *Advertiser* 13 November 1900, p.5
- 'Wanted to Sell', *Advertiser* 21 December 1906, p.12
- 'Amusements', *Express and Telegraph* 1 March 1909, p.2
- 'A Treat for the Children', *Port Pirie Recorder and North Western Mail* 18 September 1909, p.3
- 'Clunes For the Hospital', *Ballarat Star* 10 August 1910, p.6
- 'Electric Light at the Seaside', *Express and Telegraph* 30 December 1914, p.4

Summary of State Heritage Place: 26552

16 of 24

Provisionally entered by the South Australian Heritage Council on 16 February 2023

Confirmed by the South Australian Heritage Council on [\[add date\]](#) (tbc)

'Merry-Go-Round Etc', *Barrier Miner* 8 May 1915, p.5  
 'The Semaphore's Great Carnival, A Great Success. A Galaxy of Amusement', *Port Adelaide News* 4 February 1916, p.3  
 'Semaphore Gala Day', *Daily Herald* 25 January 1919, p.7  
 'Tramways Military Band', *Port Adelaide News* 19 December 1919, p.4  
 'Amusements', *Register* 14 January 1920, p.2  
 'Another Big Improvement at Semaphore', *Port Adelaide News* 16 March 1923, p.5  
 'New Company Registered', *News* 23 October 1923, p.4  
 'Semaphore Palais', *Port Adelaide News* 31 October 1924, p.1  
 'Fire in City. Currie Street Building Burned. Much Minor Damage Done', *Recorder (Port Pirie)* 25 April 1925, p.1  
 'Dispute Over Wages, Charge Against Employer', *News* 20 July 1925, p.1  
 'Semaphore Beach, Amusement Park Scheme, Protest Likely', *News* 19 August 1925, p.8  
 'Semaphore Beach Scheme', *News* 21 August 1925, p.3  
 'Proposal to Lease Semaphore Beach', *News* 21 August 1925, p.4  
 'The Semaphore Beach Company's Proposal Rejected', *Port Adelaide News* 2 October 1925, p.7  
 'Henley Committees', *News* 10 December 1925, p.15  
 'Semaphore Carnival, The Concluding Sports', *Register* 2 February 1926, p.13  
 'Henley Beach Regatta', *Register* 5 November 1926, p.4  
 'Henley Improvements', *Register* 29 January 1927, p.8  
 'New Work for Builders. Semaphore Hotel', *Register* 14 July 1927, p.4  
 'Councillor Kills Snake', *News* 13 October 1927, p.1  
 'Sideshow Season on Beaches, Variety in Entertainment and Amusement, Revenue used to Improve Foreshores', *News* 22 November 1928, p.23  
 'Record Crowds at Beaches', *News* 29 December 1928, p.3  
 'Amusements', *Advertiser* 23 August 1930, p.2  
 'Semaphore Carnival', *News* 21 October 1930, p.3  
 'New Attractions for Zoo. Large Musical Merry-go-round', *Argus* 25 May 1931, p.7  
 'Semaphore Carnival Continues, Baby Show Yesterday', *Advertiser* 24 January 1935, p.15  
 'Accommodation for 1,500 at Semaphore and Largs', *Advertiser* 10 April 1936, p.8  
 'Centenary Camp at Semaphore', *News* 3 September 1936, p.24  
 'Semaphore Indignation at Plan to Lease Site for Merry-go-round', *News* 19 November 1936, p.14  
 'Broken Hill Holiday-Makers Arrive at Semaphore, Trip was First Train Ride for Twenty of the Visiting Families, Also Gaze on Sea for First Time', *News* 21 December 1936, p.10  
 'Pinnaroo Residents to Camp at Semaphore', *News* 5 January 1937, p.6  
 'Semaphore Carnival Starts this Week, Three-Day Gala', *Advertiser* 26 January 1937, p.10  
 'Obituary. Mr. F. W. Baxter', *Age (Melbourne)* 27 May 1937, p.12  
 'Pioneer of Steam Hurdy-Gurdy, Career of Late Mr. Baxter', *Mail* 29 May 1937, p.8  
 'Pioneer of Steam Hurdy-Gurdy. Career of Late Mr. Baxter', *Border Watch* 3 June 1937, p.5  
 'Plans for Summer at Seaside Resorts, Preparations for Large Crowds, Improvements Made', *Advertiser* 4 November, 1938. p.14  
 'Carnival Site', *Citizen* 31 December 1938, p.1  
 Mr. Pim, 'Passing By: Pioneer Showman', *News* 30 December 1938, p.4  
 'Semaphore On Top, Simple Story Told in Headlines, Now No. 1 Beach', *Citizen* 31 December 1938, p.1  
 '8,000 Barrierites Here for Xmas, Five Excursion Trains for Zinc and Combined Committees, Forth Successive Year of Cheap Fares Plan', *Mail* 5 November, 1939 p.8  
 'Semaphore Victory Carnival, Opening Date Now January 26', *Advertiser* 13 December 1945, p.5  
 'Semaphore Camp for Barrier Visitors', *Advertiser* 15 April 1947, p.4  
 Mr. Pim, 'Passing By: Ex-Navy Man', *News* 27 April 1949, p.5  
 'Still Going Round After 47 Years', *Mail* 7 January 1950, p.34  
 'The Merry-Go-Round Man', *Progressive Times* 1 February 1950, p.25  
 'Wayville Face-lift, Plans for Show', *News* 26 August 1950, p.9

'Death of Henley Alderman', *Advertiser* 27 April 1951, p. 4  
'Looking along YOUR street', *News* 30 December 1952, p.9  
'Miners start holiday influx', *Mail* 19 December 1953, p.7  
'Old horses never die, they just go around merrily', *Messenger* 10 August 1988, Port Adelaide Enfield Local History Collection  
'Horses on the Comeback Trail', *Portside Messenger* 26 April 1989, Port Adelaide Enfield Local History Collection  
Matt Deighton, 'New spin on Semaphore's historic carousel', *Portside Messenger* 12 November 1997, p.3, Port Adelaide Enfield Local History Collection  
'Ekka antique merry-go-round banned over injury fears', *Courier Mail* 6 August 2008  
'Fun times ahead in Rundle Mall revamp, Shopping boost in roundabout way', *Sunday Mail* 16 October 2011  
James Quast, 'Saddling up for another year', *Portside Messenger* 9 January 2002, p.3.

### Websites

History of Luna Park <https://lunapark.com.au/plan-your-visit/history-of-luna-park/> accessed 6 February 2023  
<https://visitcanberra.com.au/attractions/56b23b19d5f1565045d7fdad/merry-go-round> accessed 6 February 2023  
<https://two-sisters.blog/2013/12/27/carousels-and-merry-go-rounds-in-australia/> 'Information Sign' in <https://www.youtube.com/watch?v=ijyITzSicqo> accessed 6 February 2023  
[https://coasterpedia.net/wiki/Carousel\\_\(Luna\\_Park\\_Sydney\)](https://coasterpedia.net/wiki/Carousel_(Luna_Park_Sydney)) accessed 6 February 2023  
[http://www.shfa.nsw.gov.au/sydney-About\\_us-Heritage\\_role-Heritage\\_and\\_Conservation\\_Register.htm&objectid=165](http://www.shfa.nsw.gov.au/sydney-About_us-Heritage_role-Heritage_and_Conservation_Register.htm&objectid=165) accessed 6 February 2023  
<https://intown.com.au/locals/geelong/attractions/carousel.htm> accessed 6 February 2023  
<https://vhd.heritagecouncil.vic.gov.au/places/4738> accessed 6 February 2023  
University of Sheffield, National Fairground Archive, History of Fairground Rides, A Chronological Development  
<https://web.archive.org/web/20110811021142/https://www.nfa.dept.shef.ac.uk/history/rides/history.html> accessed 23 December 2022  
<https://www.museums.norfolk.gov.uk/-/media/museums/downloads/learning/kings-lynn/a-history-of-savages.pdf> accessed 4 January 2023  
<https://www.herrickpickups.com/origins-of-the-electro-magnetic-pickup/> accessed 4 January 2023  
Ashley Walsh, 'Semaphore's Historic Carousel' ABC Local Radio 9 November 2008  
<https://www.abc.net.au/local/stories/2008/11/09/2414408.htm>

### Archival

GRG24/96 Register of correspondence - Places of Public Entertainment (Reference Book) SRSA  
GRG67/33 Correspondence files, annual single number series - Places of Public Entertainment SRSA  
GRS/838 Council and committee minutes - Town of Henley and Grange, later City of Henley and Grange SRSA  
Brett Leighton, Notes (1989), Port Adelaide Enfield Local History Collection  
John Dallwitz, Heritage South Australia Photographic Collection Film 109/3, 15 August 1979

## SITE DETAILS

Semaphore Carousel  
Esplanade, Semaphore

PLACE NO.: 26522

---

**DESCRIPTION OF PLACE:** Carousel and pavilion  
**DATE OF CONSTRUCTION:** 1928, relocated 1938  
**REGISTER STATUS:** Nominated 8 August 2022  
Provisional entry 16 February 2023  
**CURRENT USE:** Carousel  
1928-Present  
**BUILDER:** Leonard R. Northey (builder)  
Robert Bartlett & Co. (horses)  
1928  
**LOCAL GOVERNMENT AREA:** City of Port Adelaide Enfield  
**LOCATION:** **Street No.:**  
**Street Name:** Esplanade  
**Town/Suburb:** Semaphore  
**Post Code:** 5019  
**LAND DESCRIPTION:** **Title** CR 6230/172 A103 D42723  
**Reference:**  
**Hundred:** Port Adelaide



## PHOTOS

Semaphore Carousel  
Esplanade, Semaphore

PLACE NO.: 26522

---



**Semaphore Carousel Pavilion, showing clerestory windows, sliding doors (closed) and mast.**

Source: DEW Files 23 December 2022



**Overall view of carousel, showing centre console, pressed metal rounding boards (top), platform and horses.**



## PHOTOS

Semaphore Carousel  
Esplanade, Semaphore

PLACE NO.: 26522



Pressed metal rounding boards (detail).



Original speaker aperture with decorative fretwork inserts (lyre motif) and cloth backing.



Oregon platform, showing slot allowing horse rods to swing outwards with centripetal motion.

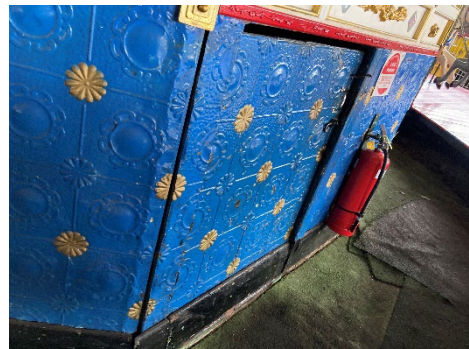

Pressed metal cladding of lower centre console and access door.

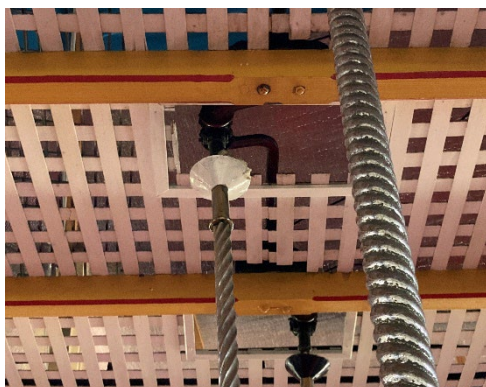

Typical connections between crankshaft and barley-twist horse rods, with oil cups.



Pressed metal soffit to centre console, with applied decoration [not original fabric].

## PHOTOS

Semaphore Carousel  
Esplanade, Semaphore

PLACE NO.: 26522



Typical horse.



Sweeps, quarterings, lattice ceiling [original fabric] with drop panels [not original fabric].



Operator's box.



Carousel controller (ex MTT tram controller).

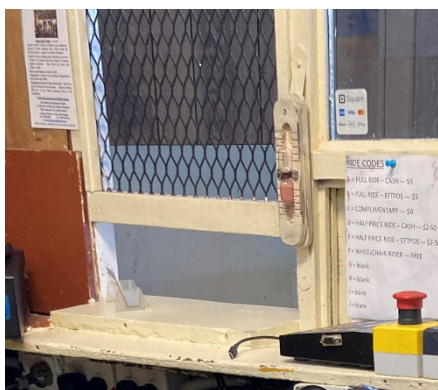

Ticket window with revolving hourglass timer (on right).



Carriages (removed from platform).



- 
- <sup>1</sup> 'New Company Registered', *News* 23 October 1923 p.4.
- <sup>2</sup> 'Fire in City. Currie Street Building Burned. Much Minor Damage Done', *Recorder* (Port Pirie) 25 April 1925, p.1.
- <sup>3</sup> 'Dispute Over Wages, Charge Against Employer', *News* 20 July 1925, p.1.
- <sup>4</sup> 'Henley Beach Regatta', *Register* 5 November 1926, p.4.
- <sup>5</sup> 'Henley Improvements', *Register* 29 January 1927, p.8.
- <sup>6</sup> 'Henley Beach Regatta', *Register* 5 November 1926 p.4.
- <sup>7</sup> Earliest mention in targeted search of TROVE: 'Henley Committees', *News* 10 December 1925, p.15.
- <sup>8</sup> 'Death of Henley Alderman', *Advertiser* 27 April 1951.
- <sup>9</sup> Corroborated, 'Councillor Kills Snake' *News* 13 October 1927.
- <sup>10</sup> Sands and McDougall's South Australian Directory (1926)
- <sup>11</sup> Brett Leighton, Notes (1989)
- <sup>12</sup> It has been claimed that Northey invested in a carousel 'rather than wait' for motion pictures with a synchronised soundtrack, known as talking pictures or 'talkies,' to 'wipe out' the silent film industry (Couper-Smartt, *Commodious Harbor* p. 578). However, Northey could not have foreseen (Dylan Walker, *Almost an Institution: Sustaining Rural Exhibition in South Australia (1897-1935)* (2017) pp. 83-85) the demise of silent cinema when he commissioned the carousel in 1927 or early 1928. Talking pictures did not arrive in Australia until early 1929, initially greeted with considerable scepticism among exhibitors, and their long-term viability was not assured until the high price of synchronised sound reproduction technology came within reach of suburban exhibitors from September 1929 (Dylan Walker, *Almost an Institution* pp. 83-85).
- <sup>13</sup> GRS838/00001/Unit 5 SRSA
- <sup>14</sup> GRS838/00001/Unit 7 n. p. SRSA
- <sup>15</sup> GRS838/00001/Unit 6, p. 56 SRSA
- <sup>16</sup> GRS838/00001/Unit 7 n. p. SRSA
- <sup>17</sup> GRS838/00001/Unit 7 n. p. SRSA
- <sup>18</sup> GRS838/00001/Unit 6, p. 27; Unit 7 n. p. SRSA
- <sup>19</sup> Brett Leighton, Notes (1989)
- <sup>20</sup> Patricia Mullins, 'Future Uncertain for South Australia's Unique Semaphore Beach Carousel', *Carousel News & Trader* February 2012 p.27.
- <sup>21</sup> Patricia Mullins, 'Future Uncertain', *Carousel News & Trader* February 2012 p.27.
- <sup>22</sup> Brett Leighton, Notes (1989)
- <sup>23</sup> Patricia Mullins, 'Future Uncertain', *Carousel News & Trader* February 2012, p.27.
- <sup>24</sup> Brett Leighton, Notes (1989)
- <sup>25</sup> This claim first appears in John Couper-Smartt, *Commodious Harbor* p.578.
- <sup>26</sup> Brett Leighton, Notes (1989); Forwood Downs possessed a crank press c.1900: [https://archival.collections.slsa.sa.gov.au/brg/BRG201\\_ForwoodHoldings\\_serieslist.pdf](https://archival.collections.slsa.sa.gov.au/brg/BRG201_ForwoodHoldings_serieslist.pdf)
- <sup>27</sup> Signage at Semaphore Carousel.
- <sup>28</sup> Brett Leighton, Notes (1989)
- <sup>29</sup> GRS838/00001/Unit 6, p. 8 SRSA
- <sup>30</sup> John Dallwitz, Heritage South Australia Photographic Collection Film 109/3, 15 August 1979
- <sup>31</sup> 'Sideshow Season on Beaches, Variety in Entertainment and Amusement, Revenue used to Improve Foreshores', *News* 22 November 1928, p.23.
- <sup>32</sup> 'Sideshow Season on Beaches'.
- <sup>33</sup> 'Old horses never die, they just go around merrily', *Messenger* 10 August 1988, Port Adelaide Enfield Local History Collection
- <sup>34</sup> Brett Leighton, Notes (1989)
- <sup>35</sup> <https://www.herrickpickups.com/origins-of-the-electro-magnetic-pickup/>
- <sup>36</sup> 'Sideshow Season on Beaches'
- <sup>37</sup> An oral source (Brett Leighton Notes, 1989) claims this initial system proved unsuccessful, leading to its replacement with the current drive in 1930. However, no physical or documentary

---

evidence is available to support the existence of any such carousel drives in South Australia during the twentieth century (no such systems appear in numerous historical photographs of carousels held in the State Library of South Australia's pictorial collection). It is unlikely such a 'hazardous' (Couper-Smartt, *Commodious Harbor* p. 578) system would have been granted a licence under the *Places of Public Entertainment Act 1913*. The steam belt drive story first emerged in the late 1980s around the time Murphy's Port Adelaide Steam Riding Gallery resurfaced; the story and may have been inspired by a nineteenth-century advertisement obtained by Peter Jenkinson and associated with the Riding Gallery, depicting an Armitage-Hershell carousel driven by a portable 'donkey' steam engine via a horizontal belt.

<sup>38</sup> Brett Leighton, Notes (1989)

<sup>39</sup> Brett Leighton, Notes (1989)

<sup>40</sup> 'Record Crowds at Beaches', *News* 29 December 1928, p.3.

<sup>41</sup> 'Amusements', *Advertiser* 23 August 1930, p.2.

<sup>42</sup> GRS838/00001/Unit 6, p. 2 SRSA

<sup>43</sup> GRS838/00001/Unit 6, pp. 55-60 SRSA

<sup>44</sup> Signage at Semaphore Carousel.

<sup>45</sup> Couper-Smartt *Commodious Harbor* p. 578; the Carousel carries a canvas roof in photographs of its appearance at Jubilee Oval.

<sup>46</sup> <https://collections.slsa.sa.gov.au/resource/B+7517>

<sup>47</sup> According to local folklore, Northey relocated his carousel to Semaphore when the Corporation of the Town of Henley and Grange increased the carousel's site rental by one shilling (Ashley Walsh, 'Semaphore's Historic Carousel' ABC Local Radio 9 November 2008 <https://www.abc.net.au/local/stories/2008/11/09/2414408.htm>). However, since the annual site rental cost over £120 per annum, and site rental growth was foreseen in Northey's original five-year lease, it seems unlikely Northey would have gone to the considerable effort and expense of relocating his carousel over a such a trivial increase.

<sup>48</sup> 'Semaphore On Top, Simple Story Told in Headlines, Now No. 1 Beach', *Citizen* 31 December 1938, p.1.

<sup>49</sup> 'Semaphore Indignation at Plan to Lease Site for Merry-go-round', *News* 19 November 1936, p.14.

<sup>50</sup> 'Plans for Summer at Seaside Resorts, Preparations for Large Crowds, Improvements Made', *Advertiser* 4 November, 1938 p.14.

<sup>51</sup> 'Carnival Site', *Citizen* 31 December 1938, p.1.

<sup>52</sup> Corporation of the City of Port Adelaide(1956), *Centenary History of Port Adelaide 1856-1956* Port Adelaide SA: Corporation of the City of Port Adelaide p.102.

<sup>53</sup> Hamish Ramsay (1988), *Semaphore Palais Conservation and Feasibility Study* Unley SA: Hamish Ramsay p.13.

<sup>54</sup> Brett Leighton, Notes (1989)

<sup>55</sup> 'The Merry-Go-Round Man', *Progressive Times* 1 February 1950, p.25.

<sup>56</sup> GRG67/33 File 243/1928 SRSA

<sup>57</sup> 'Old horses never die'

<sup>58</sup> James Quast, 'Saddling up for another year', *Portside Messenger* 9 January 2002, p.3.

<sup>59</sup> Patricia Mullins, 'Future Uncertain', *Carousel News & Trader* February 2012, p.29.

<sup>60</sup> Patricia Mullins, 'Future Uncertain', *Carousel News & Trader* February 2012, p.29.

<sup>61</sup> Patricia Mullins, 'Future Uncertain', *Carousel News & Trader* February 2012, p.29.

<sup>62</sup> 'Fun times ahead in Rundle Mall revamp, Shopping boost in roundabout way', *Sunday Mail* 16 October 2011.

<sup>63</sup> Couper-Smartt, *Commodious Harbor* p. 578.

<sup>64</sup> Couper-Smartt, *Commodious Harbor* p. 579.

<sup>65</sup> 'Old horses never die'

<sup>66</sup> Patricia Mullins, 'Future Uncertain', *Carousel News & Trader* February 2012, p.30.

<sup>67</sup> Brett Leighton, Notes (1989).